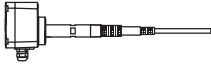
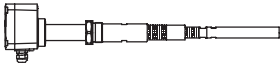
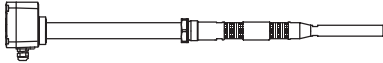

Table of content

	Page
Overview	2
Applications	4
<hr style="border-top: 1px dashed black;"/>	
RF 3100 Standard version	6
	
<hr style="border-top: 1px dashed black;"/>	
RF 3200 Heavy Duty version	8
	
<hr style="border-top: 1px dashed black;"/>	
RF 3300 High temperature version	10
	
<hr style="border-top: 1px dashed black;"/>	
Options	12
Dimensions	17
Detailed Ex-markings	22
Electrical installation	23
Spare parts	24

Subject to change.

All dimensions in mm (inches).

All prices in Euro (€) or USD (\$),
excluding VAT.

All EURO prices are EXW Betzigau,
all USD prices are EXW Memphis,
excluding packaging costs.

Valid: From 01.04.2021 until 31.03.2022, unless otherwise
agreed.

By publishing this selection list all other lists become invalid.

We assume no liability for typing errors.

Different variations to those specified are possible.
Please contact our technical consultants.

Overview

- Level limit detection in bulk goods/ solids
- Compact unit
- Wide range of applications
- No maintenance
- Full, demand, empty detector
- Aluminium or plastics housing
- RF technology
- Active shield technology
- Self diagnostics
- Auto calibration
- ATEX, IEC-Ex, FM, FMc, TR-CU, KC, CCC
GasEx and DustEx approvals
- FDA and 1935/2004/EC
Food grade materials

Approvals	CE/ TR-CU	
	ATEX/ IEC-Ex/ TR-CU	
	Zone 20/21	Dust Ignition Proof
	Zone 1	Flameproof/ Increased Safety
	KC/ CCC	
	Zone 20/21	Dust Ignition Proof
	Zone 1	Flameproof
	FM/ FMc	
	General purp.	
	FM	
	Cl. II, III Div. 1	Dust Ignition Proof
	Cl. I Div. 1 Cl. I Zone 1	Explosionproof

Electronics	Supply voltage/ Signal output	21 .. 230 V AC/ DC ±10% Relais DPDT
	Technology	RF with active shield
	Signal output delay	0.5 .. 60 sec
	Measuring range/ max.s ensitivity	3 .. 100 pF/ 0.5 pF 3 .. 400 pF/ 2 pF
	Preset sensitivy	2 pF default, other sensitivity optional
	Calibration	Auto power up calibration at first time operation Auto recalibration with uncovered probe Push button calibration Manual calibration
	Display	4 digit LCD Display of actual measured capacitance, signal output state and self diagnostics
	Self diagnostics	Auto or manual function test Over and Under Range Actual calibrated switchpoint capacitance Min. and max. electronics temperature

Housings		
Standard Aluminium	d Aluminium	de Aluminium
		

Overview

RF 3100 Standard version	
Total length L	200 .. 2,500 mm (7.9 .. 98.4") rod 450 .. 20,000 mm (17.7 .. 787") rope
Active rod/ rope diameter	Rod \varnothing 10 mm (\varnothing 0.39") Rope \varnothing 4 mm (\varnothing 0.16")
Ambient temperature	-40 .. +70°C (-40 .. 158°F) Ex flameproof/XP +60°C (140°F)
Process temperature	-40 .. +240°C (-40 .. +464°F)
Process pressure	-1 .. +25 bar (-14.5 .. +363 psi)
Lateral load (rod version)	max. 20 Nm (\varnothing 10 mm probe), max. 125 Nm (\varnothing 22 mm pipe)
Tensile load (rope version)	max. 4 kN
Process connection material/ Extension material	1.4301/ 1.4305/ 1.4541 (SS303/ 304/ 321) or 1.4404/ 1.4401 (SS316L/ 316)
Probe isolation material	PPS reinforced FDA and 1935/2004/EC conform
Probe gasket material	FKM

Rod version
Shortest length



Rod version
Inactive extension



Rope version
Inactive extension



Remote version



Overview / Applications

RF 3200 Heavy Duty version	
Total length L	300 .. 2,500 mm (11.8 .. 98.4") rod 550 .. 20,000 mm (21.7 .. 787") rope
Active rod/ rope diameter	Rod \varnothing 22 mm (\varnothing 0.87") Rope \varnothing 8 mm (\varnothing 0.31")
Ambient temperature	-40 .. +70°C (-40 .. +158°F) Ex flameproof/XP +60°C (140°F)
Process temperature	-40 .. +240°C (-40 .. +464°F)
Process pressure	-1 .. +25 bar (-14.5 .. +363 psi)
Lateral load (rod version)	max. 90 Nm (\varnothing 22 mm probe), max. 525 Nm (\varnothing 33 mm pipe)
Tensile load (rope version)	max. 40 kN
Process connection material/ Extension material	1.4301/ 1.4305/ 1.4541 (SS303/ 304/ 321) or 1.4404/ 1.4401 (SS316L/ 316)
Probe isolation material	PPS reinforced FDA and 1935/2004/EC conform
Probe gasket material	FKM or FFKM



Example:
Rod version

RF 3300 High temperature version	
Total length L	320 ... 2,500 mm (12.6 .. 98.4") rod 570 .. 20,000 mm (22.4 .. 787") rope
Active rod/ rope diameter	Rod \varnothing 22 mm (\varnothing 0.39") Rope \varnothing 8 mm (\varnothing 0.16")
Ambient temperature	-40 .. +70°C (-40 .. +158°F) Ex flameproof/XP +60°C (140°F)
Process temperature	-40 .. +500°C (-40 .. +932°F) Ex versions: +445°C (833°F)
Process pressure	-1 .. +10bar (-14.5 .. +145 psi)
Lateral load (rod version)	max. 20 Nm (\varnothing 22 mm probe), max. 525 Nm (\varnothing 33 mm pipe)
Tensile load (rope version)	max. 10 kN
Process connection material/ Extension material	1.4301/ 1.4305/ 1.4541 (SS303/ 304/ 321) or 1.4404/ 1.4401 (SS316L/ 316)
Probe isolation material	Ceramic FDA and 1935/2004/EC conform
Probe gasket material	Graphite



Example:
Rod version

Applications

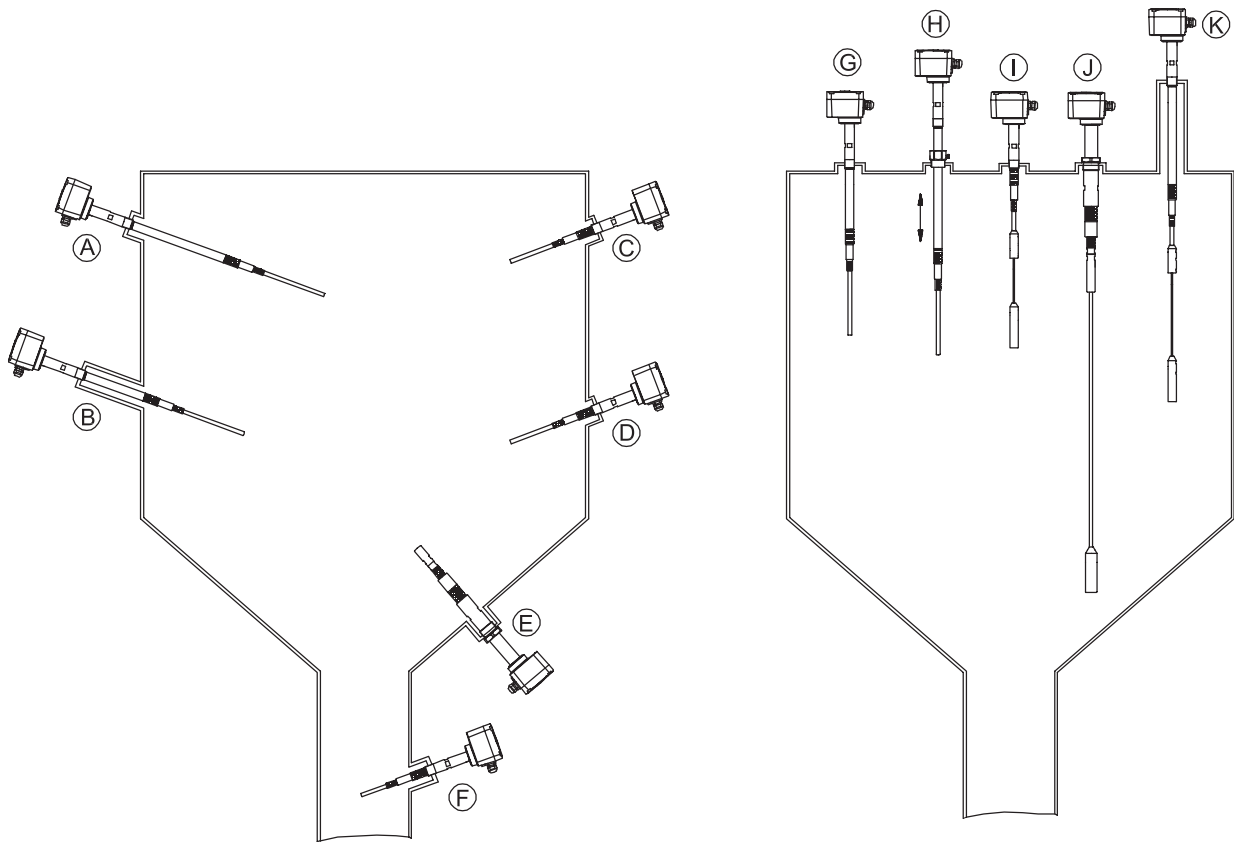

		RF 3100	RF 3200	RF 3300
(A)	Inactive length to reach distance from silo wall	•	•	•
(B)	Inactive length due to long mounting nozzle	•	•	•
(C)	Full detector with short length	•	•	•
(D)	Demand detector with short length, observe max. load	•	•	•
(E)	Empty detector with short length, observe max. load	•	•	•
(F)	Application in down pipe, observe max. load	•	•	•
(G)	Inactive length to bring active probe to required level	•	•	•
(H)	Inactive length and sliding sleeve for adjustable height	•	•	
(I)	Full detector, rope version	•	•	•
(J)	Empty detector, rope version, observe max. load	•	•	•
(K)	Inactive length due to long mounting nozzle	•	•	•

RF 3100 Standard version

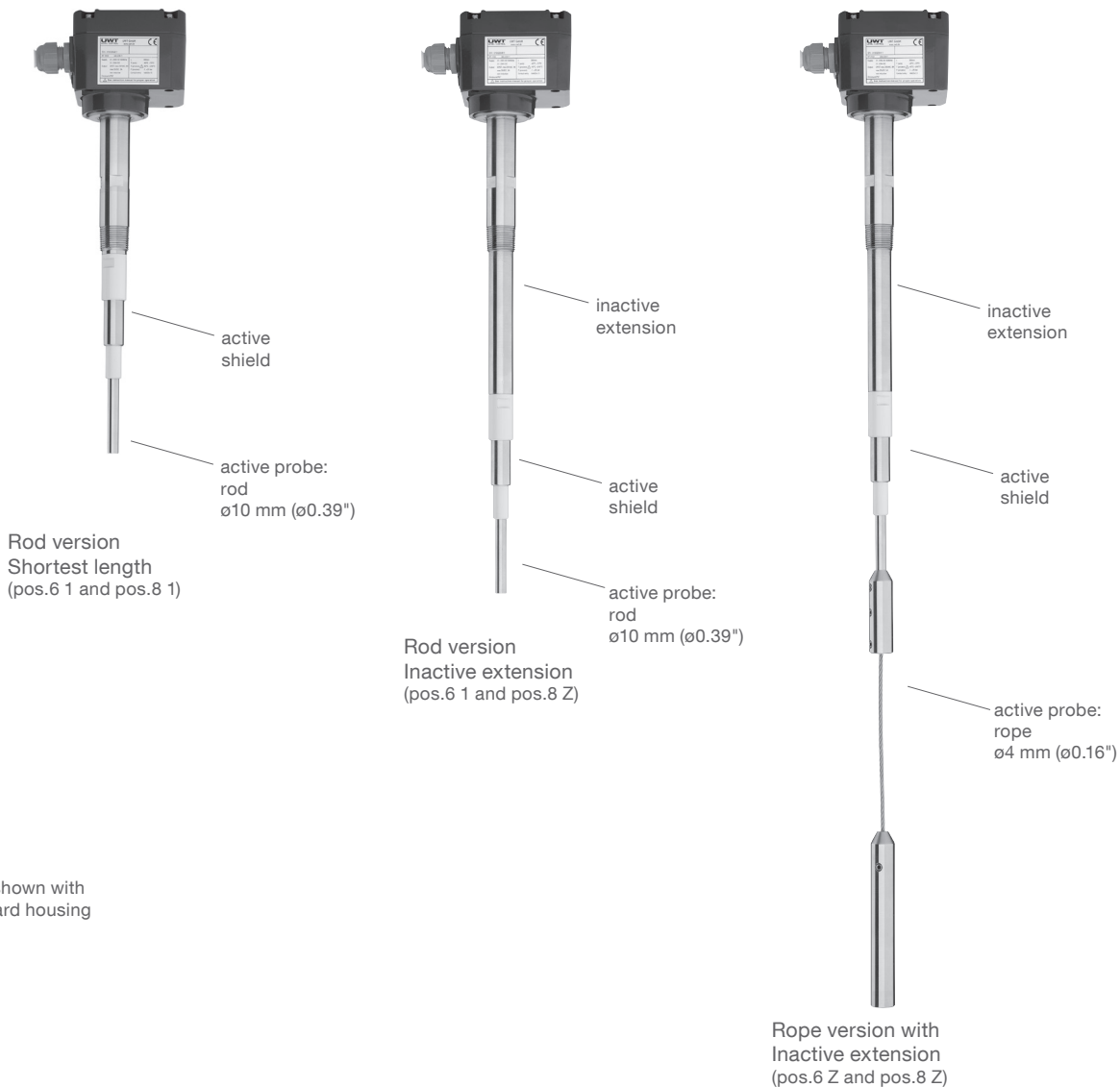

Units shown with
 Standard housing

Cable entries (by default)

Depending on model selected, the following cable entries are supported (options see pos.33 on page 13):

Version:	Cable entries:
Flameproof (pos.2 T,D,L,5)	M20 x 1.5 (1x open conduit + 1x blind plug)
FM/FMc (pos.2 M,N,U)	NPT 1/2" tapered ANSI B1.20.1 (1x open conduit + 1x blind plug)
All other versions	M20 x 1.5 (1x screwed cable gland + 1x blind plug)

Length L1

Rod version,
 horizontal mounting

DK*	L1 (pos.6)/ mm (inch)
<1.5	n.a.
≥1.6	≥300 (11.8")
≥1.8	≥200 (7.9")
≥2.2	≥100 (3.9")
≥10	≥50 (2.0")

*see external
 DK table

With stated L1 the unit works with factory setted sensitivity (2 pF). For shorter L1 see option pos.16

Switchpoint

Rope version

x mm (inch)
n.a.
≤300 (11.8")
≤200 (7.9")
≤100 (3.9")
≤50 (2.0")

The table states the switchpoint with factory setted sensitivity (2 pF). For smaller x see option pos.16

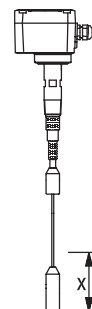

Dimensions see pages 17, 18

RF 3100 Standard version

Basic type

RF 3100

pos.2 **Certificate** (detailed Ex-markings: see page 22)

	Dust	Gas	Protection method
0	CE/ TR-CU	-	-
W	ATEX	Zone 20/21	Dust Ignition Proof
R	ATEX	Zone 20/21	Flameproof/ Increased Safety/ Dust Ignition Proof
T	ATEX	Zone 20/21	Flameproof/ Dust Ignition Proof
A	IEC-Ex	Zone 20/21	Dust Ignition Proof
C	IEC-Ex	Zone 20/21	Flameproof/ Increased Safety/ Dust Ignition Proof
D	IEC-Ex	Zone 20/21	Flameproof/ Dust Ignition Proof
M	FM/ FMc	-	General purpose
N	FM	Cl. II, III, Div.1	Dust Ignition Proof
U	FM	Cl. II, III, Div.1	Explosion Proof/ Dust Ignition Proof
E	TR-CU	Zone 20/21	Dust Ignition Proof
K	TR-CU	Zone 20/21	Flameproof/ Increased Safety/ Dust Ignition Proof
L	TR-CU	Zone 20/21	Flameproof/ Dust Ignition Proof
2	Further ⁽¹⁾	Zone 20/21	Dust Ignition Proof
5	Further ⁽¹⁾	Zone 20/21	Flameproof/ Dust Ignition Proof

pos.4 **Electronic module**

L Relay DPDT 21 .. 230 V AC/ DC

pos.5 **Process connection**

- A Thread G 1½", DIN 228
- B Thread G 1¼", DIN 228
- C Thread G 1", DIN 228
- W Thread G ¾", DIN 228
- D Thread M32 x 1.5
- E Thread M30 x 1.5
- F Thread NPT 1½", conical ANSI B1.20.1
- Q Thread NPT 1¼", conical ANSI B1.20.1
- G Thread NPT 1", conical ANSI B1.20.1
- J Thread NPT ¾", conical ANSI B1.20.1
- P Triclamp 2" (DN50) ISO 2852
- R Triclamp 1" (DN25) and 1½" (DN40) ISO 2852
- L Flange DN100 PN6, EN 1092-1 (max. 6 bar (87 psi))
- M Flange DN100 PN16, EN 1092-1 (max. 16 bar (232 psi))
- S Flange 2" 150lbs ANSI B16.5 (max. 10 bar (145 psi))
- T Flange 3" 150lbs ANSI B16.5 (max. 10 bar (145 psi))
- U Flange 4" 150lbs ANSI B16.5 (max. 10 bar (145 psi))

pos.6 **Active Probe length L1⁽²⁾**

- 1 Rod, L1=100 mm (3.94")
- 2 Rod, L1=200 mm (7.87")
- 3 Rod, L1=300 mm (11.8")
- Y Rod, L1=custom specified Price per 100 mm (3.94") or part thereof (starting from 0 mm) min. L1=50 mm (1.97"), max. L1=2,000 mm (78.7")
- Z Rope, Base price Price per 100 mm (3.94") or part thereof (starting from 0 mm) min. L1=350 mm (13.8"), max. L1=20,000 mm (787"), observe max. load

pos.8 **Inactive extension length L2^(3,4)**

- 1 Without
- Z L2=custom specified Base price Price per 100 mm (3.94") or part thereof (starting from 0 mm) Rod version: min. L2=50 mm (1.97"), max. L2=2,400 mm (94.5") - L1 Rope version: min. L2=50 mm (1.97"), max. L2=1,900 mm (74.8")

pos.9 **Material of process connection and extension "L"**

- 1 Stainless steel 1.4301/ 1.4305/ 1.4541 (303/ 304/ 321) and PPS, gaskets FKM
- 2 Stainless steel 1.4404 (316L), 1.4401 (316) for rope, PPS, gaskets FKM

Further options: see page 12

⁽¹⁾ Local certificates see option 15/ page 12

⁽²⁾ See recommendations on page before

⁽³⁾ Inactive extension: the active probe shall have at least 50 mm (1.97") distance to the vessel wall

⁽⁴⁾ Total length L = L1 + L2 + 100 mm (3.94")

RF 3100	A	3	L			A			
Position	1	2	3	4	5	6	7	8	9

L1 =	mm
L2 =	mm

← Order code

All positions are available with special design (use code "Z").

RF 3200 Heavy Duty version

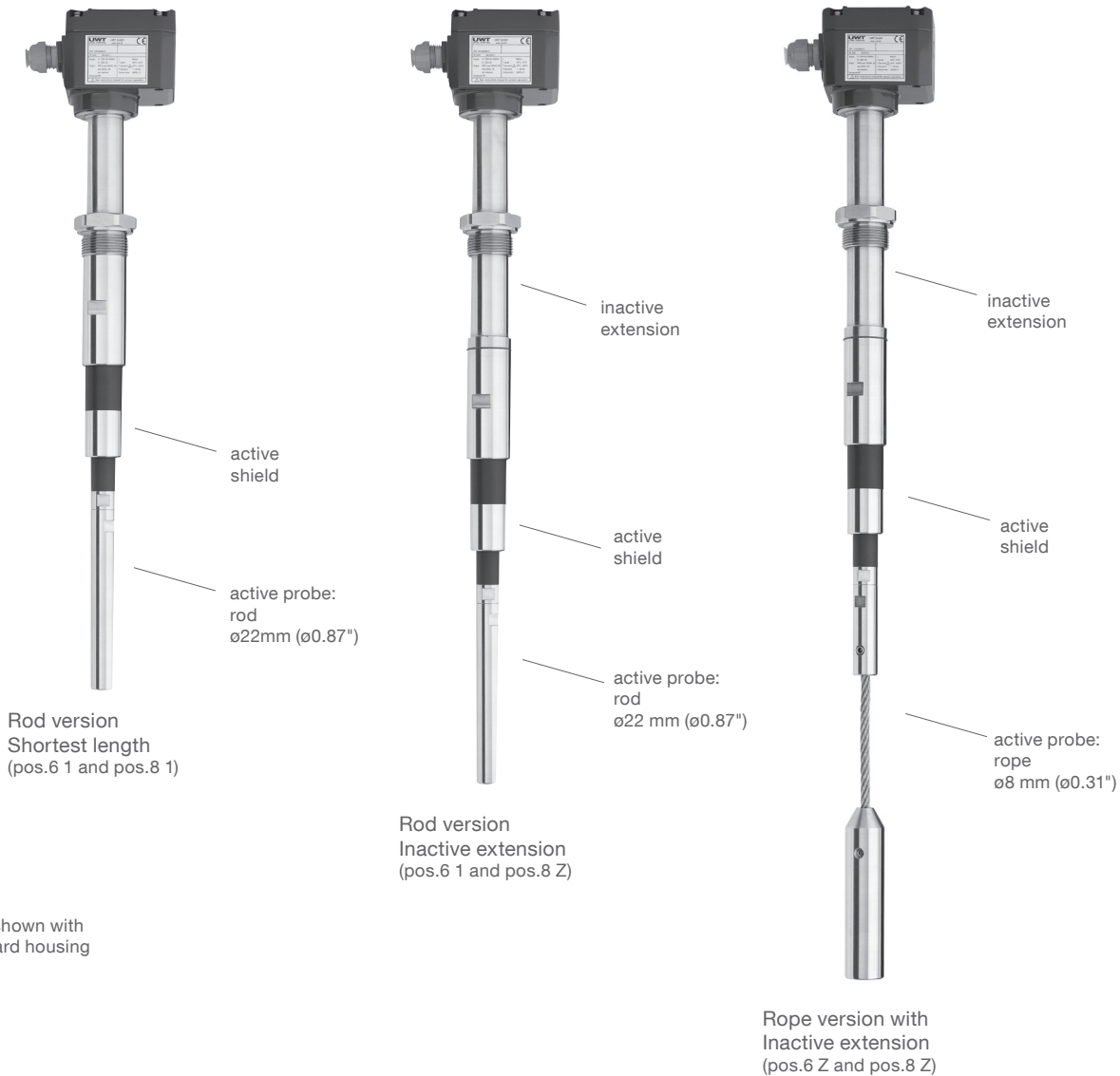

Units shown with Standard housing

Cable entries (by default)

Depending on model selected, the following cable entries are supported (options see pos.33 on page 13):

Version:	Cable entries:
Flameproof (pos.2 T,D,L,5)	M20 x 1.5 (1x open conduit + 1x blind plug)
FM/FMc (pos.2 M,N,U)	NPT 1/2" tapered ANSI B1.20.1 (1x open conduit + 1x blind plug)
All other versions	M20 x 1.5 (1x screwed cable gland + 1x blind plug)

Length L1

Rod version, horizontal mounting

DK*	L1 (pos.6)/ mm (inch)
<1.5	n.a.
≥1.6	≥300 (11.8")
≥1.8	≥200 (7.9")
≥2.2	≥100 (3.9")
≥10	≥50 (2.0")

*see external DK table

With stated L1 the unit works with factory setted sensitivity (2 pF). For shorter L1 see option pos.16

Switchpoint

Rope version

x mm (inch)
n.a.
≤300 (11.8")
≤200 (7.9")
≤100 (3.9")
≤50 (2.0")

The table states the switchpoint with factory setted sensitivity (2 pF). For smaller x see option pos.16

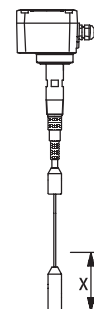

Dimensions see pages 17, 19

RF 3200 Heavy Duty version

Basic type

RF 3200 ●

pos.2 **Certificate** (detailed Ex-markings: see page 22)

	Dust	Gas	Protection method
0	CE/ TR-CU	-	-
W	ATEX	Zone 20/21	-
R	ATEX	Zone 20/21	Zone 1
T	ATEX	Zone 20/21	Zone 1
A	IEC-Ex	Zone 20/21	-
C	IEC-Ex	Zone 20/21	Zone 1
D	IEC-Ex	Zone 20/21	Zone 1
M	FM/ FMc	-	-
N	FM	Cl. II, III, Div.1	-
U	FM	Cl. II, III, Div.1	Cl. I Div.1/ Zone 1
E	TR-CU	Zone 20/21	-
K	TR-CU	Zone 20/21	Zone 1
L	TR-CU	Zone 20/21	Zone 1
2	Further ⁽¹⁾	Zone 20/21	-
5	Further ⁽¹⁾	Zone 20/21	Zone 1

pos.4 **Electronic module**

L Relay DPDT 21 .. 230 V AC/ DC ●

pos.5 **Process connection**

- A Thread G 1½", DIN 228 ● ●
- B Thread G 1¼", DIN 228 ● ●
- F Thread NPT 1½", conical ANSI B1.20.1 ● ●
- Q Thread NPT 1¼", conical ANSI B1.20.1 ● ●
- L Flange DN100 PN6, EN 1092-1 (max. 6 bar (87 psi)) ● ●
- M Flange DN100 PN16, EN 1092-1 (max. 16 bar (232 psi)) ● ●
- S Flange 2" 150lbs ANSI B16.5 (max. 10 bar (145 psi)) ● ●
- T Flange 3" 150lbs ANSI B16.5 (max. 10 bar (145 psi)) ● ●
- U Flange 4" 150lbs ANSI B16.5 (max. 10 bar (145 psi)) ● ●

pos.6 **Active Probe length L1⁽²⁾**

- 1 Rod, L1=100 mm (3.94") ● ●
- 2 Rod, L1=200 mm (7.87") ● ●
- 3 Rod, L1=300 mm (11.8") ● ●
- Y Rod, L1=custom specified Price per 100 mm (3.94") or part thereof (starting from 0 mm) ● ●
 min. L1=100 mm (3.94"), max. L1=2,000 mm (78.7")
- Z Rope, Base price ● ●
 L1=custom specified Price per 100 mm (3.94") or part thereof (starting from 0 mm) ● ●
 min. L1=350 mm (13.8"), max. L1=20,000 mm (787")

pos.8 **Inactive extension length L2^(3,4)**

- 1 Without ● ●
- Z L2=custom specified Price per 100 mm (3.94") or part thereof (starting from 0 mm) ● ●
 Rod version: min. L2=100 mm (3.93"), max. L2=2,300 mm (90.6") - L1
 Rope version: min. L2=100 mm (3.93"), max. L2=1,800 mm (70.9")

pos.9 **Material of process connection and extension "L"**

- 1 Stainless steel 1.4301/ 1.4305/1 .4541 (303/ 304/ 321) and PPS, gaskets FKM
- 2 Stainless steel 1.4404 (316L), 1.4401 (316) for rope, PPS, gaskets FKM

Further options: see page 12

⁽¹⁾ Local certificates see option 15/ page 12

⁽²⁾ See recommendations on page before

⁽³⁾ Inactive extension: the active probe shall have at least 50 mm (1.97") distance to the vessel wall

⁽⁴⁾ Total length L = L1 + L2 + 200 mm (7.87")

RF 3200	B	3	L	A					
Position	1	2	3	4	5	6	7	8	9

L1 =	mm
L2 =	mm

← **Order code**

All positions are available with special design (use code "Z").

RF 3300 High Temperature version (500°C)

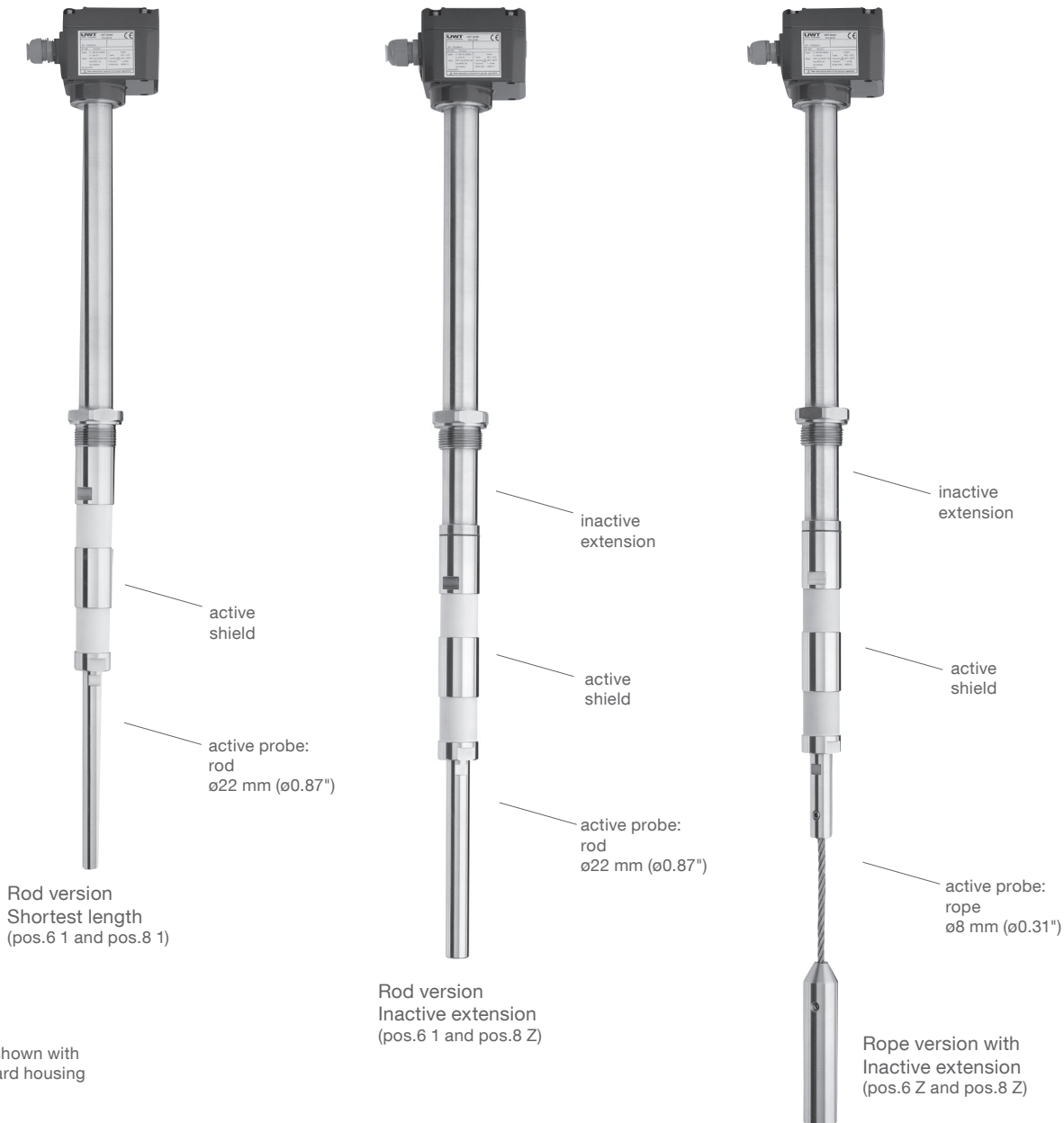

Units shown with Standard housing

Cable entries (by default)

Depending on model selected, the following cable entries are supported (options see pos.33 on page 13):

Version:	Cable entries:
Flameproof (pos.2 T,D,L,5)	M20 x 1.5 (1x open conduit + 1x blind plug)
FM/FMc (pos.2 M,N,U)	NPT ½" tapered ANSI B1.20.1 (1x open conduit + 1x blind plug)
All other versions	M20 x 1.5 (1x screwed cable gland + 1x blind plug)

Length L1

Rod version, horizontal mounting

DK*	L1 (pos.6)/ mm (inch)
<1.5	n.a.
≥1.6	≥300 (11.8")
≥1.8	≥200 (7.9")
≥2.2	≥100 (3.9")
≥10	≥50 (2.0")

*see external DK table

With stated L1 the unit works with factory setted sensitivity (2 pF). For shorter L1 see option pos.16

Switchpoint

Rope version

x mm (inch)
n.a.
≤300 (11.8")
≤200 (7.9")
≤100 (3.9")
≤50 (2.0")

The table states the switchpoint with factory setted sensitivity (2 pF). For smaller x see option pos.16

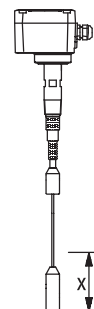

Dimensions see pages 17, 20

RF 3300 High Temperature version (500°C)

Basic type

RF 3300 ●

pos.2 **Certificate** ⁽¹⁾ (detailed Ex-markings: see page 22)

	Dust	Gas	Protection method
0	CE/ TR-CU	-	-
W	ATEX Zone 20/21	-	Dust Ignition Proof
R	ATEX Zone 20/21	Zone 1	Flameproof/ Increased Safety/ Dust Ignition Proof
T	ATEX Zone 20/21	Zone 1	Flameproof/ Dust Ignition Proof
A	IEC-Ex Zone 20/21	-	Dust Ignition Proof
C	IEC-Ex Zone 20/21	Zone 1	Flameproof/ Increased Safety/ Dust Ignition Proof
D	IEC-Ex Zone 20/21	Zone 1	Flameproof/ Dust Ignition Proof
M	FM/ FMc	-	General purpose
N	FM Cl. II, III, Div.1	-	Dust Ignition Proof
U	FM Cl. II, III, Div.1	Cl. I Div.1/ Zone 1	Explosion Proof/ Dust Ignition Proof
E	TR-CU Zone 20/21	-	Dust Ignition Proof
K	TR-CU Zone 20/21	Zone 1	Flameproof/ Increased Safety/ Dust Ignition Proof
L	TR-CU Zone 20/21	Zone 1	Flameproof/ Dust Ignition Proof
2	Further ⁽²⁾ Zone 20/21	-	Dust Ignition Proof
5	Further ⁽²⁾ Zone 20/21	Zone 1	Flameproof/ Dust Ignition Proof

pos.4 **Electronic module**

L Relay DPDT 21 .. 230 V AC/ DC ●

pos.5 **Process connection**

- A Thread G 1½", DIN 228 ● ●
- B Thread G 1¼", DIN 228 ● ●
- F Thread NPT 1½", conical ANSI B1.20.1 ● ●
- Q Thread NPT 1¼", conical ANSI B1.20.1 ● ●
- L Flange DN100 PN6, EN 1092-1 (max. 6 bar (87 psi)) ● ●
- M Flange DN100 PN16, EN 1092-1 ● ●
- S Flange 2" 150lbs ANSI B16.5 ● ●
- T Flange 3" 150lbs ANSI B16.5 ● ●
- U Flange 4" 150lbs ANSI B16.5 ● ●

pos.6 **Active Probe length L1** ⁽³⁾

- 1 Rod, L1=100 mm (3.94") ● ●
- 2 Rod, L1=200 mm (7.87") ● ●
- 3 Rod, L1=300 mm (11.8") ● ●
- Y Rod, L1=custom specified Price per 100 mm (3.94") or part thereof (starting from 0 mm) ● ●
 min. L1=100 mm (3.94"), max. L1=1,000 mm (39.4")
- Z Rope, Base price ● ●
 L1=custom specified Price per 100 mm (3.94") or part thereof (starting from 0 mm) ● ●
 min. L1=350 mm (13.8"), max. L1=20,000 mm (787")

pos.8 **Inactive extension length L2** ^(4,5)

- 1 Without ● ●
- Z L2=custom specified Price per 100 mm (3.94") or part thereof (starting from 0 mm) ● ●
 Rod version: min. L2=100 mm (3.93"), max. L2=2,300 mm (90.6") - L1
 Rope version: min. L2=100 mm (3.93"), max. L2=1,800 mm (70.9")

pos.9 **Material of process connection and extension "L"**

- 1 Stainless steel 1.4301/ 1.4305/ 1.4541 (303/ 304/ 321) and ceramic, gaskets graphite
- 2 Stainless steel 1.4404 (316L), 1.4401 (316) for rope, ceramic, gaskets graphite

Further options: see page 12

⁽¹⁾ Max. process temperature for Ex versions limited to 445°C
⁽²⁾ Local certificates see option 15/ page 12
⁽³⁾ See recommendations on page before
⁽⁴⁾ Inactive extension: the active probe shall have at least 50 mm (1.97") distance to the vessel wall
⁽⁵⁾ Total length L = L1 + L2 + 220 mm (8.66")

RF 3300	C	5	L	A					
Position	1	2	3	4	5	6	7	8	9

L1 =	mm
L2 =	mm

← **Order code**

All positions are available with special design (use code "Z").

Options

RF 3100	RF 3200	RF 3300			
• •			pos.11 x	Guarantee extension to 5 years	•
				Remote version:	
1 1 1			pos.12 x	Remote version	•
				Including hexagon nut, not including remote cable and angle bracket	
1 1 1			pos.13 a	Remote cable, both sides wired	
				Spezial Triaxial cable, min. 1,000 mm (39.4"), max. 20,000 mm (65ft)	
				Basic price	•
				Price per 1,000 mm (39.4") or part there of (starting from 0 mm)	•
1 1 1			pos.13 x	Remote cable, not wired specify cable length, price per 1,000 mm (39.4")	•
				Special triaxial cable, no other cable permitted, max. 20,000 mm (65ft)	
1 1 1			pos.14 x	Angle bracket aluminium	•
				Local certificates:	
				Certificate (Zone and type of protection acc. to selection in pos.2 2 to pos.2 5)	
• • •			pos.15 b	KC	•
• • •			pos.15 c	CCC	•
				Electronics:	
				Presettet sensitivity	•
				Standard calibration is 2 pF, other sensitivities as follows:	
• • •			pos.16 a	0,5 pF	
• • •			pos.16 b	1 pF	
• • •			pos.16 c	4 pF	
• • •			pos.16 d	10 pF	
				Probes:	
				Probe gaskets	
• •			pos.17 a	Material FFKM, for increased requirements (such as superheated steam applications) on request	
				Coating (coating material PFA)	
2			pos.18 a	Coating of active probe (rod version)	•
3			pos.18 b	Coating of complete probe (rod version) L1=50...400 mm (1.97...15.7"), L2=50...360mm (1.97...14.2")	•
3			pos.18 d	Coating of complete probe (rod version) L1=50...400 mm (1.97...15.7"), L2=361...1000mm (14.2...39.4")	•
4			pos.18 c	Coating of rope (rope version), price per meter or part thereof	•
				Rod extension kit, rigid	
5			pos.19 a	For ø10 mm (ø0.39") rod, length 400 mm (15.7"), 1.4404 (316L)	•
• •			pos.19 b	For ø22 mm (ø0.87") rod, length 400 mm (15.7"), 1.4404 (316L)	•
				Rod extension kit, flexible (pendulum rod)	
5			pos.20 a	For ø10 mm (ø0.39") rod, length 1,000 mm (39.4"), 1.4301/ 1.4305 (304/303)	•
				Rope extension kit	
5			pos.21 a	For ø10 mm (ø0.39") rod, rope ø4 mm (ø0.16"), length 2,000 mm (78.7"), 1.4301/ 1.4305 (304/ 303)	•
5			pos.21 b	For ø10 mm (ø0.39") rod, rope ø4 mm (ø0.16"), length 2,000 mm (78.7"), 1.4404 (316L)/ rope 1.4401(316)	•
• •			pos.21 c	For ø22 mm (ø0.87") rod, rope ø8 mm (ø0.31"), length 2,000 mm (78.7"), 1.4404 (316L)/ rope 1.4401(316)	•
			pos.22 x	Fixing hole in probe rod	
•				For ø10 mm (ø0.39") rod, for fixing of the extensions. Not with pos.18 and pos.25	•
				Mounting:	
				Sliding sleeve	
6 6			pos.24 a	Material 1.4305/ 1.4541 (303/321)	•
6 6			pos.24 b	Material 1.4404 (316L)	•
				EHEDG approval (Type ED Class I)	
7			pos.25 a	Process connection G 1½" (without flush welding socket)	•
7			pos.25 b	Process connection flush welding socket ø69/ G 1½" made of aluminium	•
7			pos.25 c	Process connection flush welding socket ø69/ G 1½" made of 1.4301 (304)	•
7			pos.25 d	Process connection flush welding socket ø69/ G 1½" made of 1.4404 (316L)	•

Options

		Mounting set for flange mounting						
		process connection flange	for counter flange with	consists of				
				screws*	nuts*	washers*	sealing**	
• • •	pos.26 c	L	hole ø18	4x M16 x 60	4x M16	4 pcs	1 pc	•
• • •	pos.26 d	L	thread M16	4x M16 x 40		4 pcs	1 pc	•
• • •	pos.26 e	M	hole ø18	8x M16 x 60	8x M16	8 pcs	1 pc	•
• • •	pos.26 f	M	thread M16	8x M16 x 40		8 pcs	1 pc	•
		* material stainless steel 1.4301 (304) **max. 240°C (464°F), material not food grade						
		Hexagon nut						
• • •	pos.27 e	For thread G 1½", G 1¼", G 1", G ¾", 1.4305 (303), 1 pc						•
• • •	pos.27 f	For thread G 1½", G 1¼", G 1", G ¾", 1.4305 (303), 2 pcs						•
		Flat sealing						
• • •	pos.28 x	For process connection thread G 1½", G 1¼", G 1", G ¾", M32 x 1.5, M30 x 1.5, max. 240°C (464°F)						•
		Housing:						
8 8 8	pos.31 a	Housing material Plastics PA6 reinforced						•
9 9 9	pos.32 x	Weather protection cover (for Ex approved for Zone 2 or 22 or Div. 2)						•
		Cable entry Selection of the following options only necessary, if a deviation from the default cable gland/ conduit is required:						
10 10 10	pos.33 x	M20 x 1.5 2x screwed cable gland						•
11 11 11	pos.33 d	M20 x 1.5 1x screwed cable gland +1x blind plug						•
12 12 12	pos.33 a	NPT ½" tapered ANSI B1.20.1 (1x conduit + 1x Ex-d blind plug)						•
13 13 13	pos.33 c	NPT ¾" tapered ANSI B1.20.1 (1x conduit + 1x Ex-d blind plug)						•
		Signal lamp						
14 14 14	pos.34 a	LED, mounted in cable gland M20 x 1.5, green						•
14 14 14	pos.34 c	LED, mounted in cable gland M20 x 1.5, red						•
15 15 15	pos.34 d	LED (transparent lid section)						•
		Plug						
16 16 16	pos.35 x	Valve connector (incl. mating plug)	4-pole (incl. PE)	max. 230 V			•	
16 16 16	pos.35 a	M12 (without mating plug)	4-pole	max. 25 V			•	
16 16 16	pos.35 b	M12 (without mating plug)	5-pole (incl. PE)	max. 60 V			•	
16 16 16	pos.35 c	Harting Han 4A (incl. mating plug)	5-pole (incl. PE)	max. 230 V			•	

- Available for all versions except KC-certificates (pos.15 b).
- Recommended with excessive, mainly conductive material buildup and for reduction of abrasion. Available for CE/ TR-CU and FM General purpose (pos.2 0,M). Max. length L1=700 mm (27.6").
- Recommended with corrosive materials. Available for CE/ TR-CU and FM General purpose (pos.2 0,M). Process connection NPT 1½", G 1½". Only with inactive extension length L2 (pos.8 Z).
- Recommended with excessive material buildup and for reduction of abrasion. Available for CE/ TR-CU and FM General purpose (pos.2 0,M).
- Available for rode version with active probe length pos.6 1,2,3. Not with PFA coating.(pos.18).
- Process connection as selected in pos.5. Material must be the same as selected in pos.9. RF 3100 available with NPT 1¼", NPT 1½", G 1¼", G 1½". RF 3200 available with NPT 1½", G 1½". Not with coating of complete probe (pos.18 b, d).
- Certificate only valid with the use of the "flush welding socket". With pos.25 a this socket must be manufactured on site. Only for G 1½" (pos.5 A). Not in combination with rope version (pos.6 Z). Not in combination with options pos.18,19,20,21,24,26,27,28. Selected length "L" is increased by 25 mm (0.98").
- Available for CE and ATEX/ IEC-Ex/ TR-CU/ KC/ CCC Dust Ignition proof (pos.2 0,W,A,E,2). Ambient temperature for ATEX/ IEC-Ex/ TR-CU/ KC/ CCC: -20°C (-4°F).
- Available for all versions except flameproof/ increased safety versions (pos.2 R,T,C,D,U,K,L,5).
- Available for all versions except flameproof version (pos.2 T,U,D,L,5).
- Available for FM version (pos.2 M,N) except flameproof version (pos.2 U).
- Available for all versions except FM (pos.2 M,N,U).
- Available for all versions except pos.2 0,W,A,M,N,E,2.
- Available for CE/ TR-CU (pos.2 0), not in combination with weather protection cover (pos.32 x) and cable entries pos.33 x,a,c. 2 LED's (24V, 80-260V) will be delivered. Without connection of LED wires to internal terminals (standard) or according to customer specification.
- Available for CE/ TR-CU (pos.2 0).
- Available for CE/ TR-CU (pos.2 0). Without connection of plug wires to internal terminals (standard) or according to customer specification.

Options

Remote version

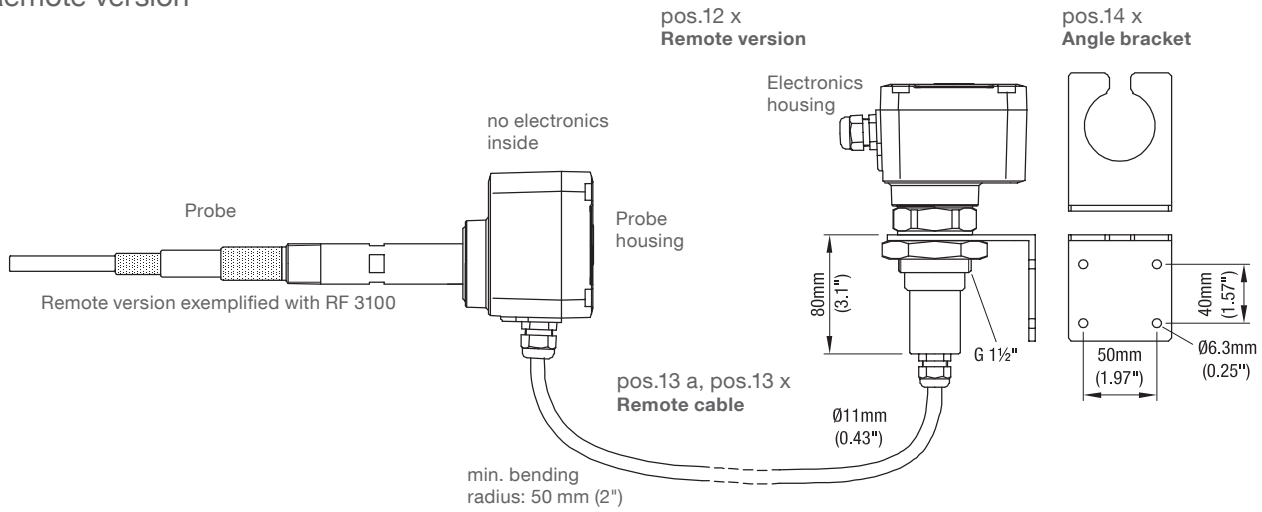

Probes

Extension kits for ø10 mm rod

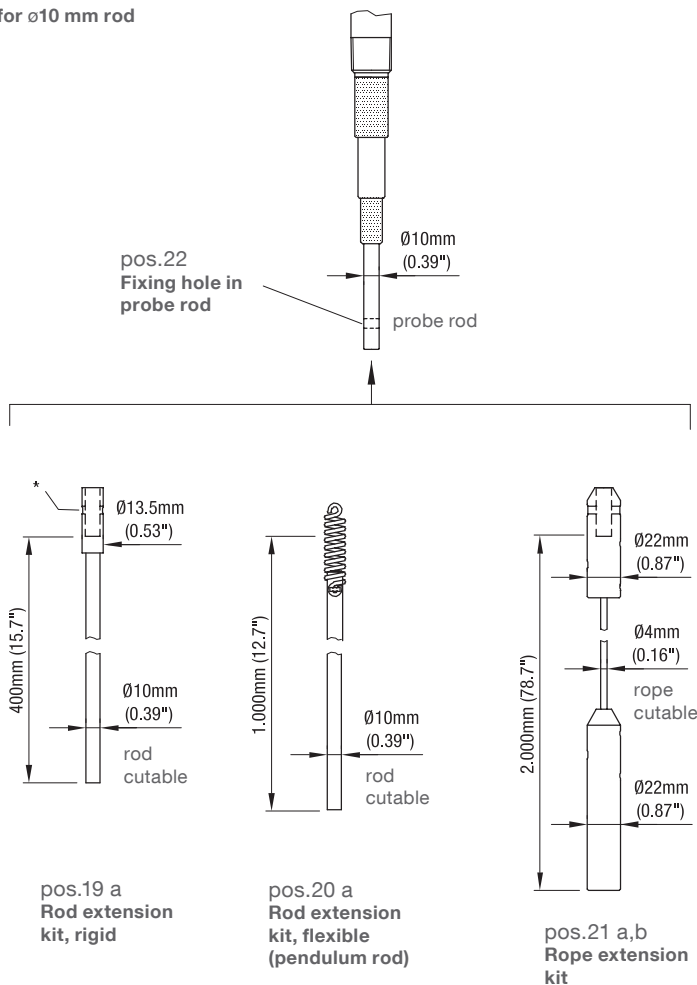

* Fixing by drilling a hole through the probe rod and fixing with a split pin

Extension kits for ø22 mm rod

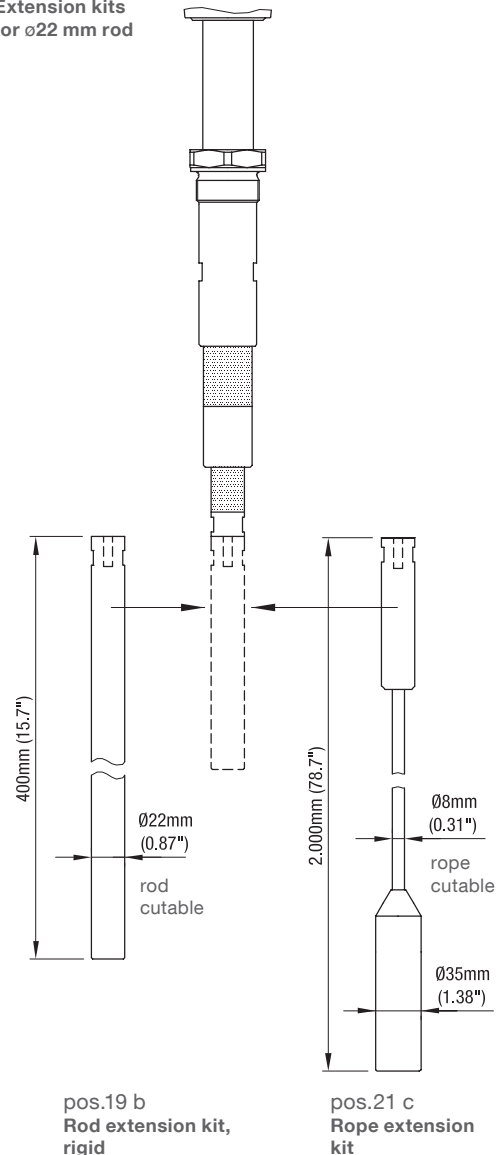

Options

Coatings

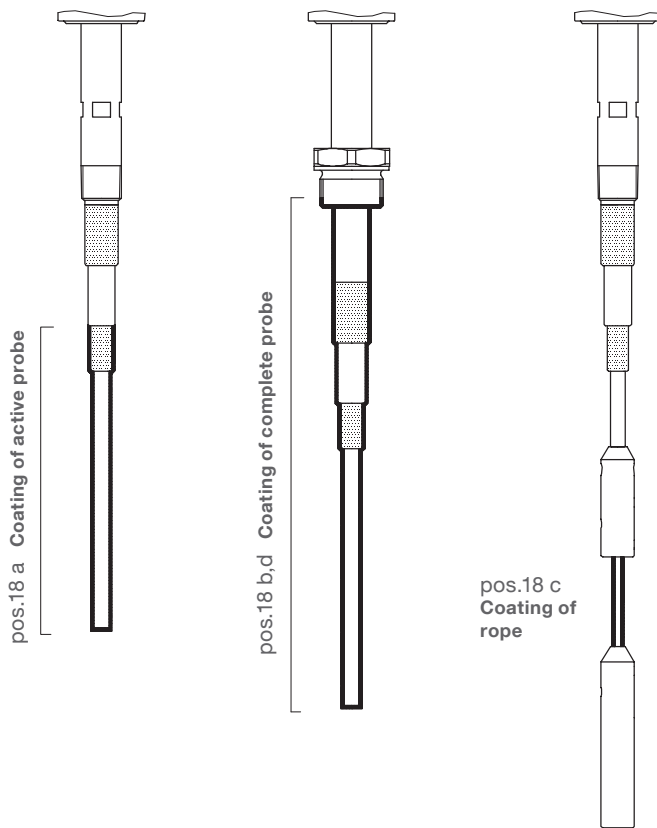

Mounting

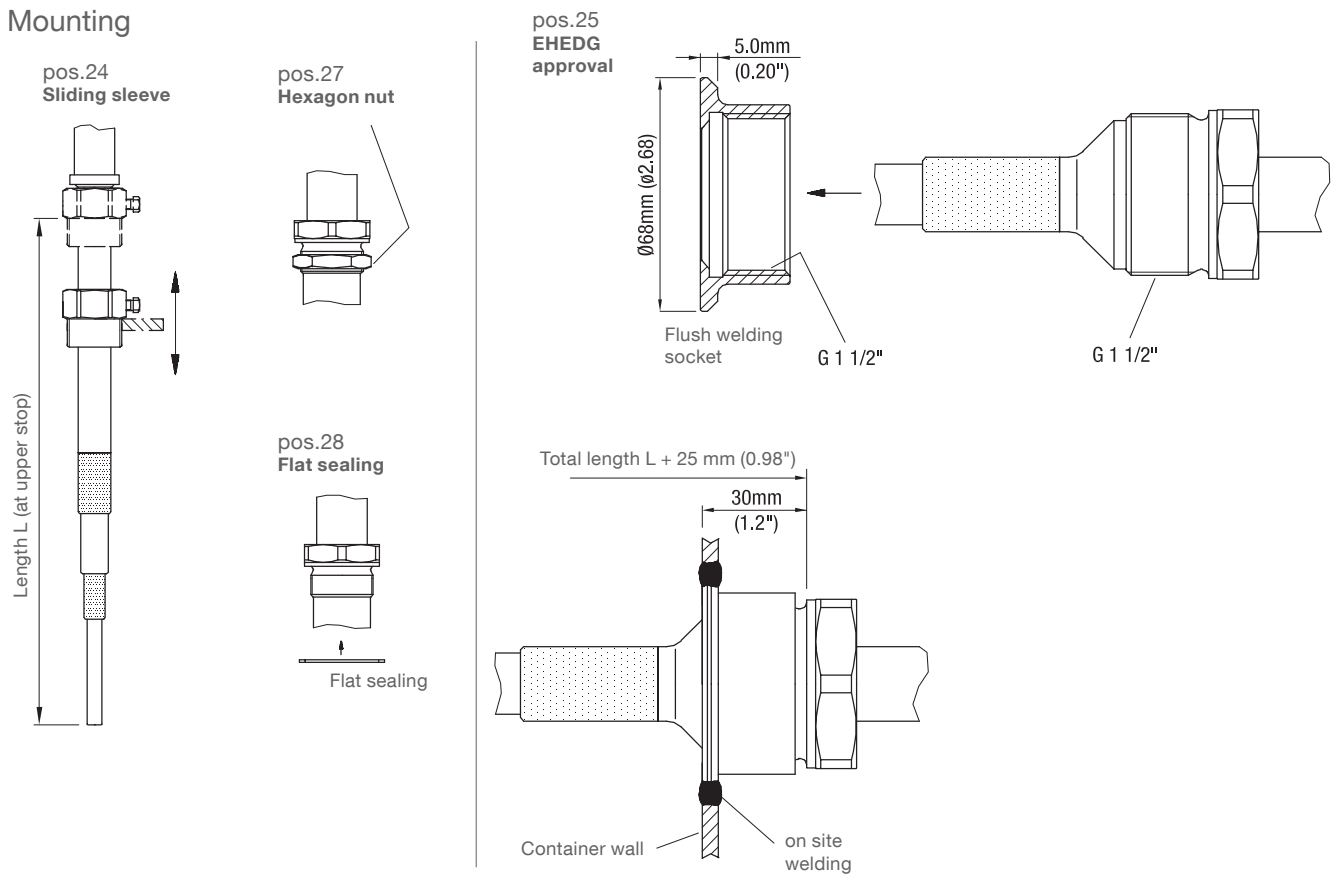

Options

Housing

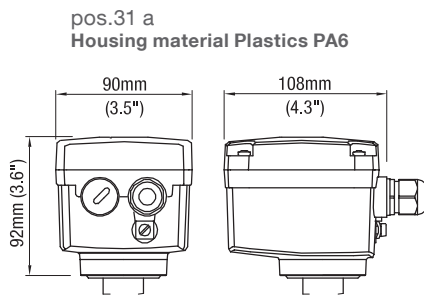

pos.32 x
 Weather protection cover

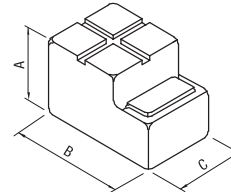

A	100 mm (3.94")
B	165 mm (6.5")
C	95 mm (3.7")

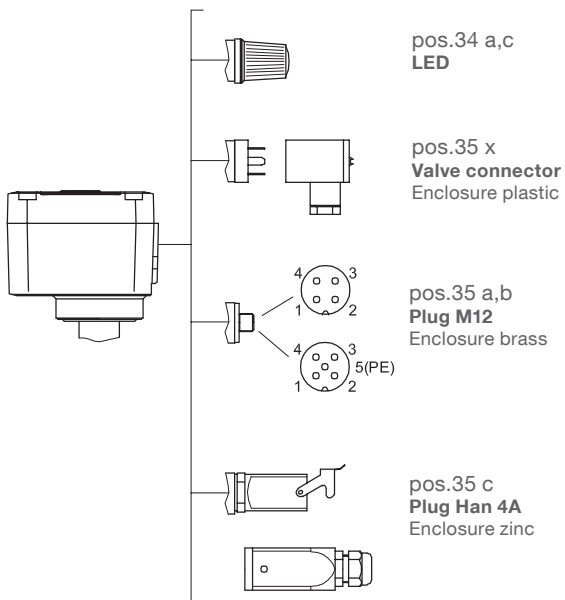

pos.34 d
 LED (transparent lid section)

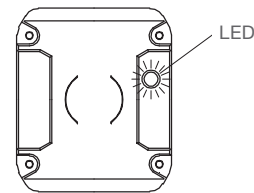

Dimensions

Housing versions

Standard

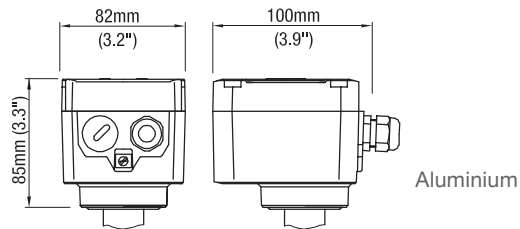

de

Explosionproof with increased safety terminal box

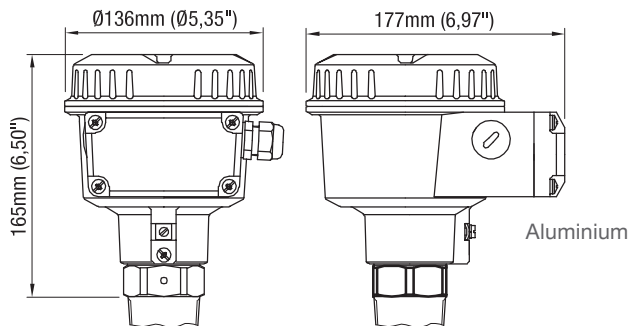

d

Flameproof/ explosionproof

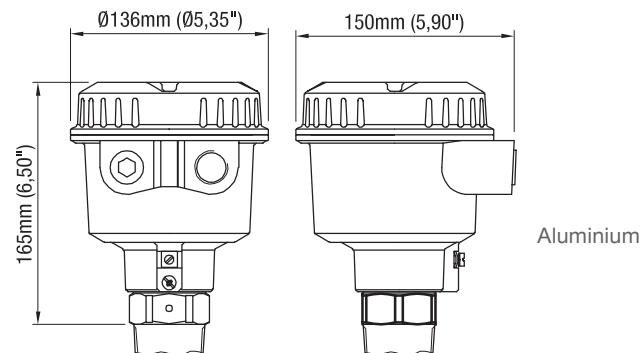

Dimensions

Probes

RF 3100 Standard version

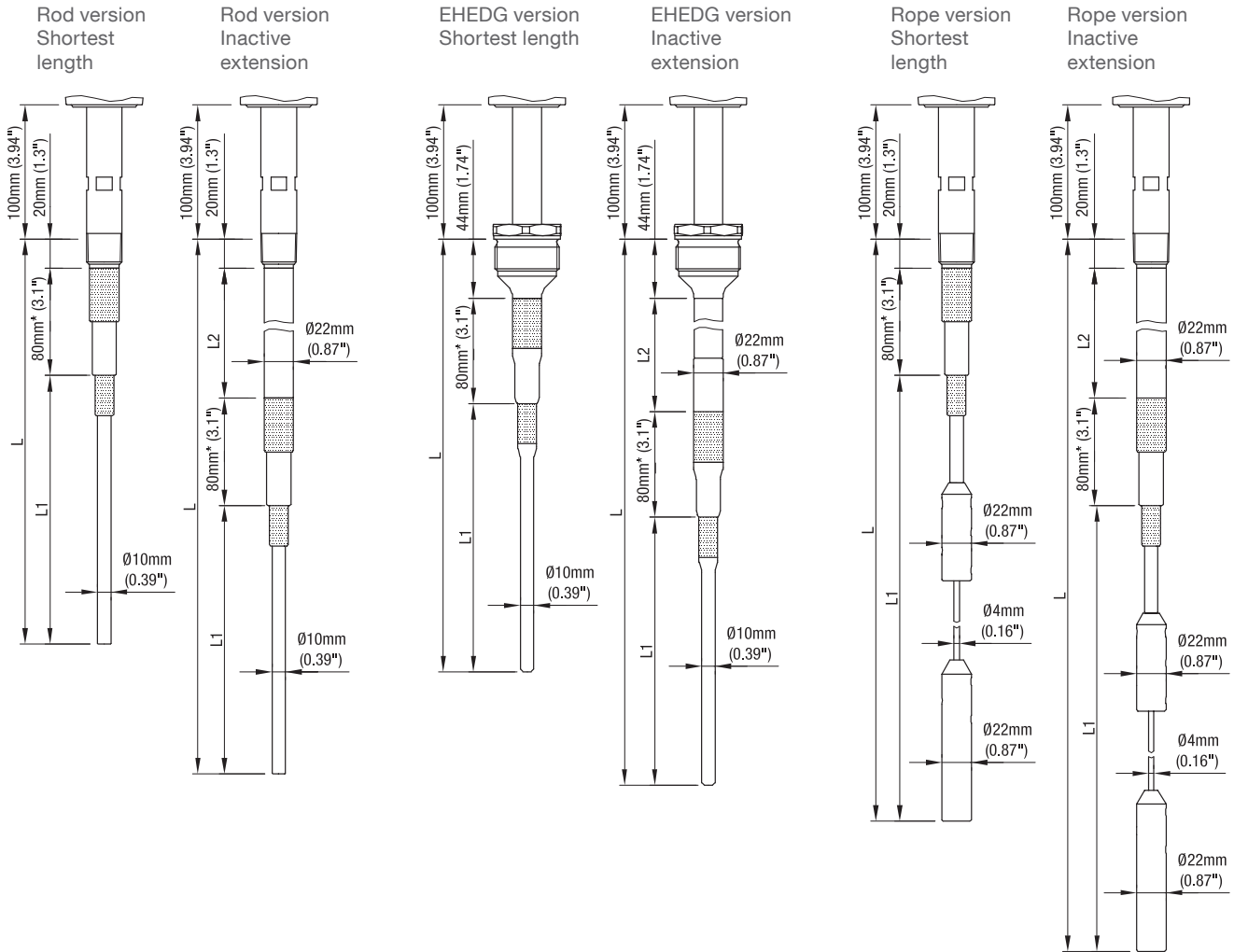

* Active shield

Only units with rod version are available with EHEDG Certificate. On rod versions with EHEDG Certificate the length "L" is increased by 25 mm (0.98").

Process connections:

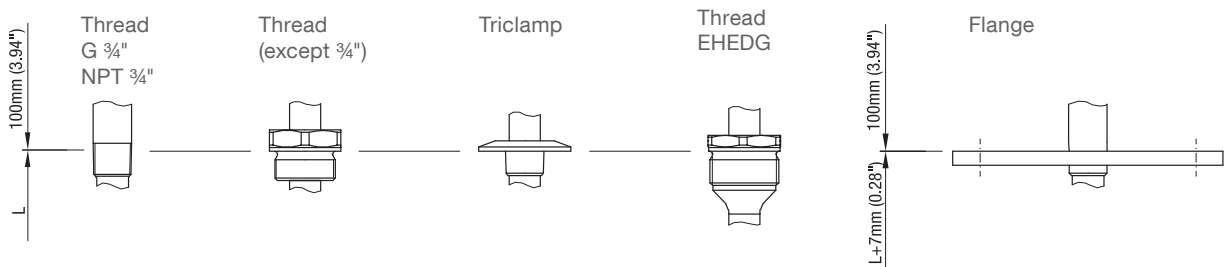

Dimensions

RF 3200 Heavy Duty version

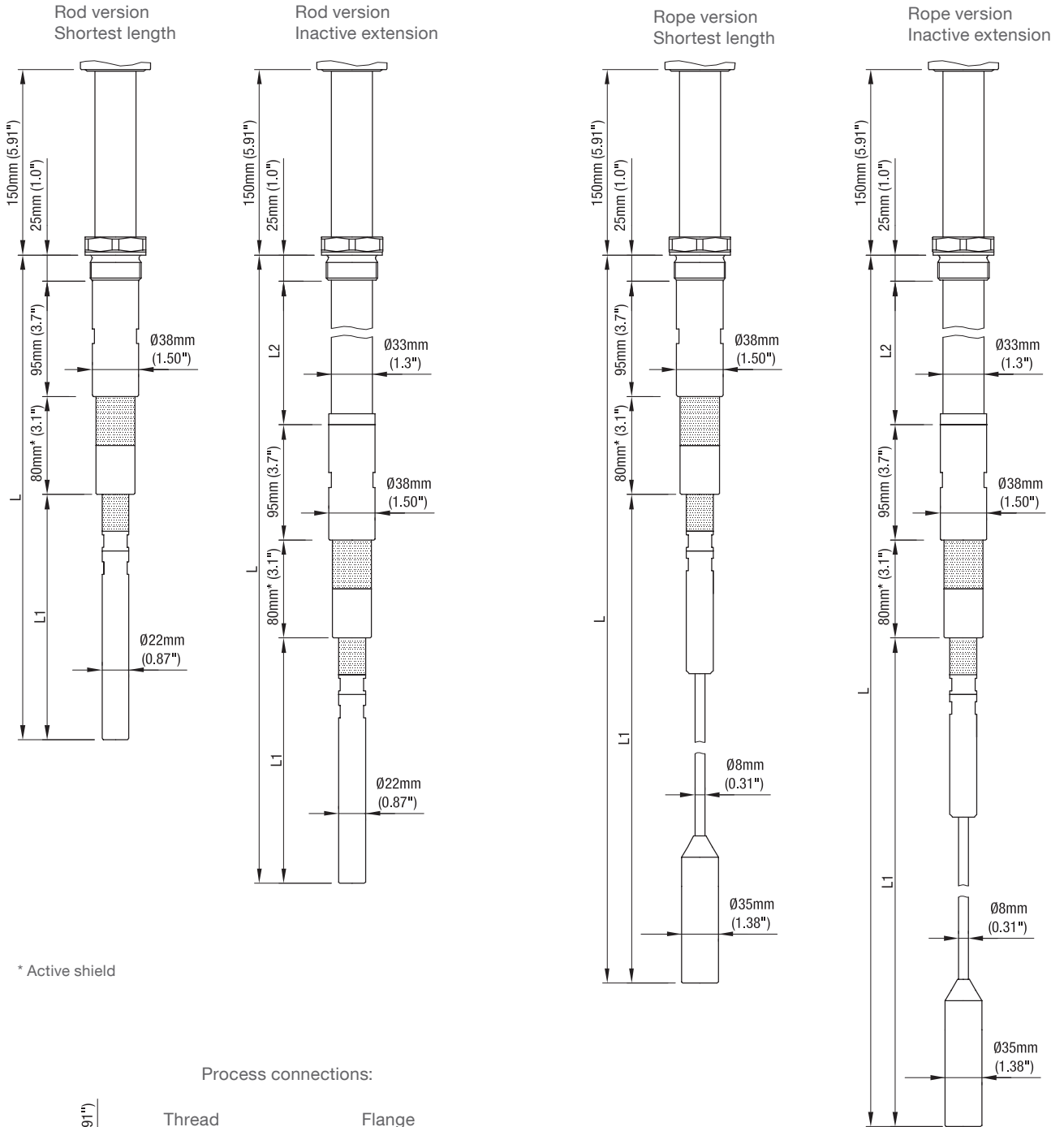

Dimensions

RF 3000 High temperature version

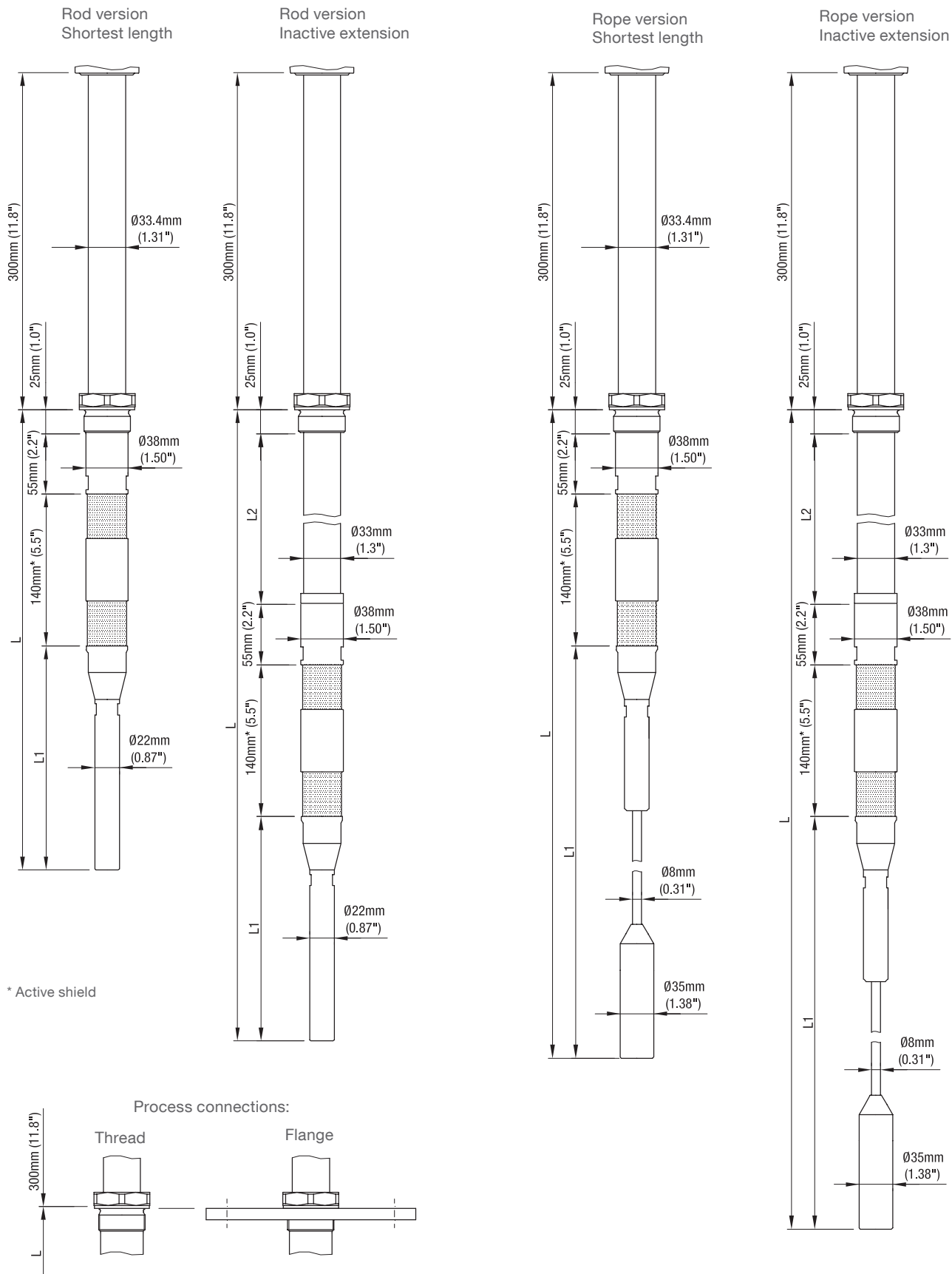

Dimensions

Flanges

Code	type	number of holes	d2	Lk	D	T (thickness)
L	Flange DN100 PN6	4	18 mm (0.71")	170 mm (6.69")	210 mm (8.27")	16 mm (0.63")
M	Flange DN100 PN16	8	18 mm (0.71")	180 mm (7.09")	220 mm (8.66")	20 mm (0.79")
S	Flange 2" 150lbs	4	19.1 mm (0.75")	120.7 mm (4.75")	152.4 mm (6.01")	19.1 mm (0.75")
T	Flange 3" 150lbs	4	19.1 mm (0.75")	152.4 mm (6.01")	190.5 mm (7.5")	23.9 mm (0.94")
U	Flange 4" 150lbs	8	19.1 mm (0.75")	190.5 mm (7.5")	228.6 mm (9.0")	23.9 mm (0.94")

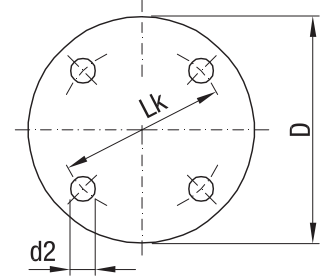

Detailed Ex-markings

Compact version (without pos.12 x)

Code	Certificate	Housing
pos.2 0	CE	Standard
pos.2 W	ATEX II 1/2D	Ex ia/tb IIIC T! Da/Db
pos.2 R	ATEX II 2G ATEX II 1/2D	Ex db eb ia IIC T! Gb Ex ia/tb IIIC T! Da/Db
pos.2 T	ATEX II 2G ATEX II 1/2D	Ex db ia IIC T! Gb Ex ia/tb IIIC T! Da/Db
pos.2 A	IEC	Ex ia/tb IIIC T! Da/Db
pos.2 C	IEC	Ex db eb ia IIC T! Gb Ex ia/tb IIIC T! Da/Db
pos.2 D	IEC	Ex db ia IIC T! Gb Ex ia/tb IIIC T! Da/Db
pos.2 M	FM/ FMc	General purpose
pos.2 N	FM	DIP-IS Cl. II, III Div.1 Gr. E,F,G
pos.2 U	FM	XP-IS Cl. I,II,III Div.1 Gr. B,C,D Cl. I Zone 1 Gr. IIB+H2 DIP-IS Cl. II, III Div.1 Gr. E,F,G
pos.2 E	TR-CU	Ex ia/tb IIIC T120°C...T445°C Da/Db X
pos.2 K	TR-CU	1Ex d e ia IIC T4...T1 Gb X Ex ia/tb IIIC T120°C...T445°C Da/Db X
pos.2 L	TR-CU	1Ex d ia IIC T4...T1 Gb X Ex ia/tb IIIC T120°C...T445°C Da/Db X
pos.2 2	+pos.15 b	KC
pos.2 5	+pos.15 b	KC
pos.2 2	+pos.15 c	CCC
pos.2 5	+pos.15 c	CCC

Remote Version (with pos.12 x)

Code	Certificate electronic housing	Electronic housing	Certificate Probe/ Probe housing
Pos.2 0	CE/ TR-CU	Standard	CE/ TR-CU
Pos.2 W	ATEX II 2D	Ex tb [ia] IIIC T! Db	ATEX II 1/2D
Pos.2 R	ATEX II 2G ATEX II 2D	Ex db eb [ia] IIC T! Gb Ex tb [ia] IIIC T! Db	ATEX II 2G
Pos.2 T	ATEX II 2G ATEX II 2D	Ex db [ia] IIC T! Gb Ex tb [ia] IIIC T! Db	ATEX II 1/2D
Pos.2 A	IEC	Ex tb [ia] IIIC T! Db	IEC
Pos.2 C	IEC	Ex db eb [ia] IIC T! Gb Ex tb [ia] IIIC T! Db	IEC
Pos.2 D	IEC	Ex db [ia] IIC T! Gb Ex tb [ia] IIIC T! Db	
Pos.2 M	FM/ FMc	General purpose	-
Pos.2 N	FM	DIP-IS Cl. II, III Div.1 Gr. E,F,G	FM
Pos.2 U	FM	XP-IS Cl. I,II,III Div.1 Gr. B,C,D Cl. I Zone 1 Gr. IIB+H2 DIP-IS Cl. II, III Div.1 Gr. E,F,G	FM
Pos.2 E	TR-CU	Ex tb [ia] IIIC T120°C Db X	TR-CU
Pos.2 K	TR-CU	1Ex d e [ia] IIC T4 Gb X Ex tb [ia] IIIC T120°C Db X	TR-CU
Pos.2 L	TR-CU	1Ex d [ia] IIC T4 Gb X Ex tb [ia] IIIC T120°C Db X	
Pos.2 2	+Pos.15 c	CCC	CCC
Pos.2 5	+Pos.15 c	CCC	CCC

Electrical installation

Universal voltage

Relay DPDT

Power supply:

21 .. 230 V 50/60 Hz or DC ±10%
 1.5 VA or 1.5 W

Fuse on power supply:
 max. 10 A, 250 V, HBC, fast or slow

Signal output:

Floating relay DPDT
 AC max. 250 V, 8 A, non inductive
 DC max. 30 V, 5 A, non inductive

Fuse on signal output:
 max. 10 A, 250 V, HBC, fast or slow

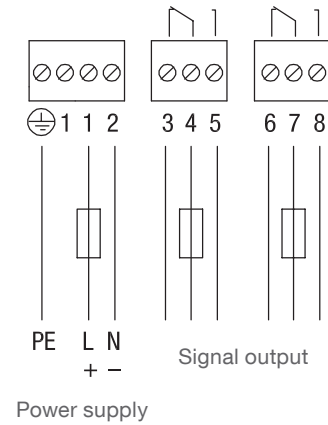

Spare parts

Minimum order value for separate orders of spare parts or accessories is 75 €.

Fitting to unit/ model code	Description see page	Spare part Article number
-----------------------------	----------------------	---------------------------

Electronics

Universal voltage, Relais DPDT	pos.3 L	7, 9, 11	pl407100	•
--------------------------------	---------	----------	----------	---

Remote version

Remote cable (special Triaxial cable), price per 1,000 mm (39.4")	pos.13 x	12, 14	zu400700	•
Angle bracket, 1.4301 (304)	pos.14 x	12, 14	zu400701	•

Rod extension kit, rigid

For ø10 mm (ø0.39") rod, length 400 mm (15.7"), 1.4404 (316L)	pos.19 a	12, 14	zu400710	•
For ø22 mm (ø0.87") rod, length 400 mm (15.7"), 1.4404 (316L)	pos.19 b	12, 14	zu400711	•

Rod extension kit, flexible (pendulum rod)

For ø10 mm (ø0.39") rod, length 1.000 mm (39.4"), 1.4301/ 1.4305 (304/303)	pos.20 a	12, 14	zu400720	•
--	----------	--------	----------	---

Rope extension kit

For ø10 mm (ø0.39") rod, rope ø4 mm (ø0.16"), length 2,000 mm (78.7"), 1.4301/ 1.4305 (304/303)	pos.21 a	12, 14	zu400730	•
For ø10mm (ø0.39") rod, rope ø4 mm (ø0.16"), length 2,000 mm (78.7"), 1.4404 (316L)/ rope 1.4401(316)	pos.21 b	12, 14	zu400731	•
For ø22 mm (ø0.87") rod, rope ø8 mm (ø0.31"), length 2,000 mm (78.7"), 1.4404 (316L)/ rope 1.4401(316)	pos.21 c	12, 14	zu400732	•

Single parts for rope version

Rope ø4 mm (ø0.16"), 1.4401 (316), not coated, price per 1,000 mm (39.4")	RF 3100	18	zu400740	•
Rope ø4 mm (ø0.16"), 1.4401 (316), coated, price per 1,000 mm (39.4")	RF 3100	18	zu400741	•
Rope weight ø22 mm (ø0.87"), 1.4301/ 1.4305 (304/ 303) *	RF 3100	18, 25	zu400742	•
Rope weight ø22 mm (ø0.87"), 1.4404 (316L) *	RF 3100	18, 25	zu400743	•
Rope holder ø22 mm (ø0.87"), 1.4301/ 1.4305 (304/303) *	RF 3100	18, 25	zu400744	•
Rope holder ø22 mm (ø0.87"), 1.4404 (316L) *	RF 3100	18, 25	zu400745	•
Rope ø8 mm (ø0.31"), 1.4401 (316), not coated, price per 1,000 mm (39.4")	RF 3200, RF 3300	19, 20	zu400746	•
Rope weight ø35 mm (ø1.38"), 1.4301/ 1.4305 (304/ 303) *	RF 3200, RF 3300	19, 20, 25	zu400747	•
Rope weight ø35 mm (ø1.38"), 1.4404 (316L) *	RF 3200, RF 3300	19, 20, 25	zu400748	•
Rope holder ø22 mm (ø0.87"), 1.4301/ 1.4305 (304/ 303) *	RF 3200, RF 3300	19, 20, 25	zu400749	•
Rope holder ø22 mm (ø0.87"), 1.4404 (316L) *	RF 3200, RF 3300	19, 20, 25	zu400750	•

*delivery including fixing parts

Hexagon nut

G 1½" 1.4305 (303)	pos.27	13, 15	zu300180	•
G 1¼" 1.4305 (303)	pos.27	13, 15	zu300181	•
G 1" 1.4305 (303)	pos.27	13, 15	zu200160	•
G ¾" 1.4305 (303)	pos.27	13, 15	zu200140	•
M32 x 1.5 1.4305 (303)	pos.27	13, 15	zu200130	•
M30 x 1.5 1.4305 (303)	pos.27	13, 15	zu200180	•

Weather protection cover

For standard housing	pos.32 x	13, 16	zu300232	•
----------------------	----------	--------	----------	---

Dimensions see pages 14, 25

Spare parts / Dimensions

Rope weight ø22 RF3100

zu400742 / zu400743
 including fixing parts
 (grub screws)

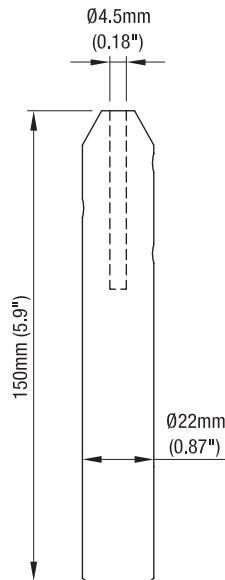

Rope holder ø22 RF3100

zu400744 / zu400745
 including fixing parts
 (split pin, grub screws)

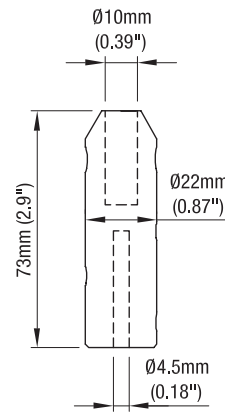

Rope weight ø35 RF3200 / RF3300

zu400747 / zu400748
 including fixing parts
 (grub screws)

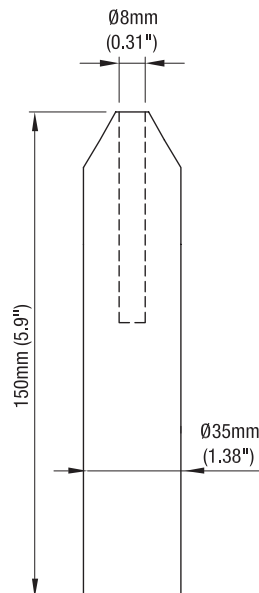

Rope holder ø22 RF3200 / RF3300

zu400749 / zu400750
 including fixing parts
 (grub screws)

